

CATALOGUE

EN

TERRACE BOARD

FENCING BOARD

WPC STEPS

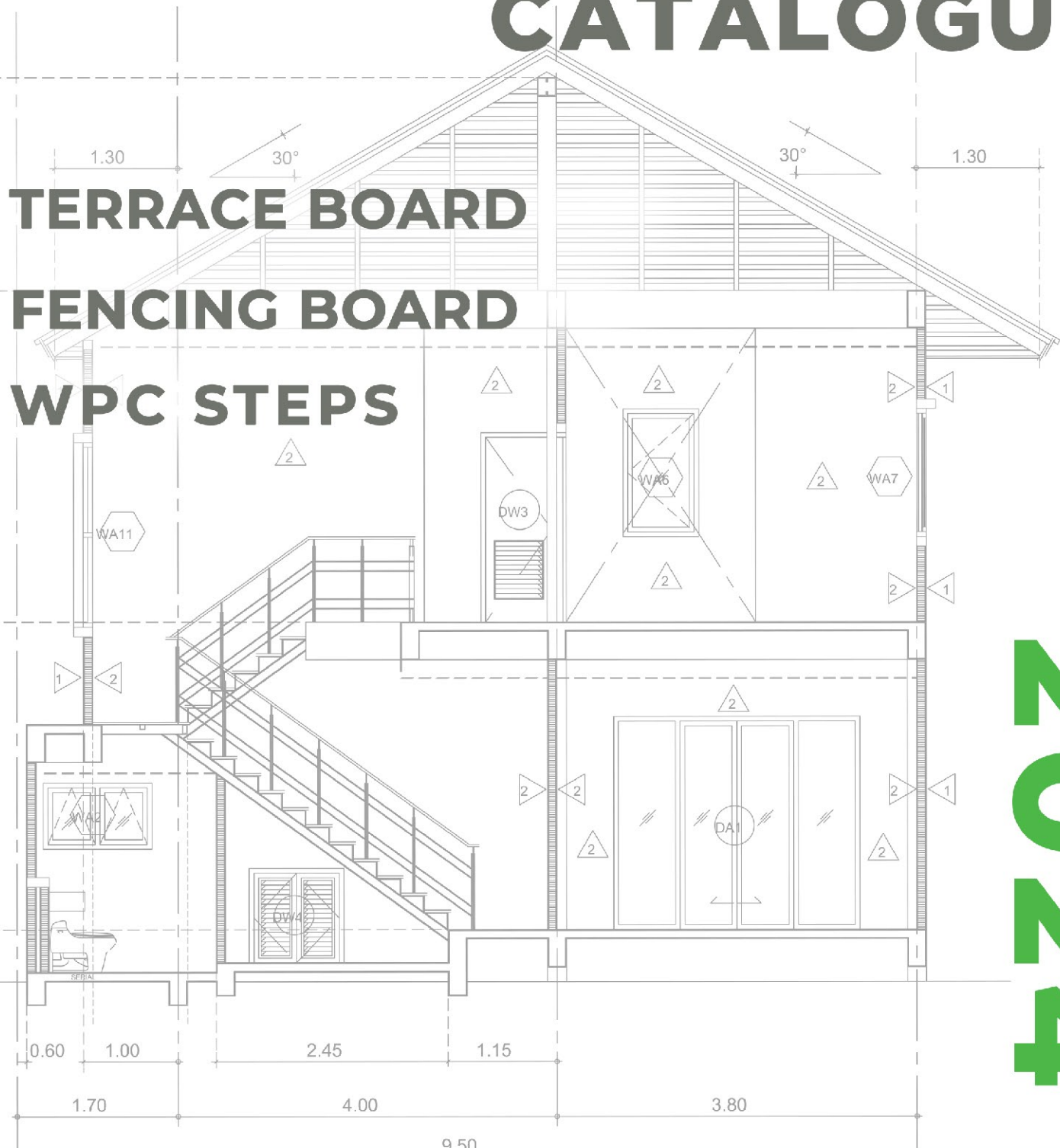

2024



**CONTACT
INFO**

RIGA, LATVIA

+371 26323290 +371 28882939

info@ecodeckprofile.lv

www.ecodeckprofile.lv

Terrace board WPC EcoDeckProfile «Premium»

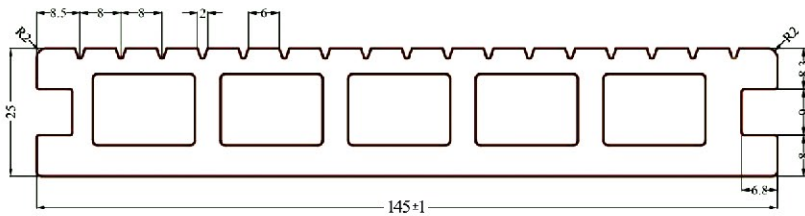

SURFACE TYPE: double-sided – "OLD WOOD" / "Velvet" or "Velvet"* / "Velvet

SIZE: 145*25 mm

LENGTH: from 1 to 12 meters

LINEAR WEIGHT: 2,54 kg

DENSITY: 1.3 g/cm³

CONSUMPTION (m.p./1m²): 6,65

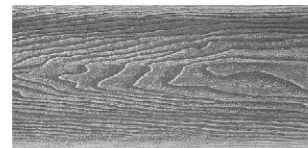

*Pine surface

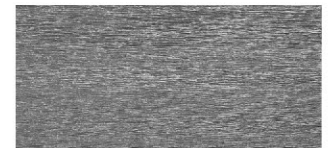

*Velvet surface

BRUSHING:

1. Double sided
2. One sided per request

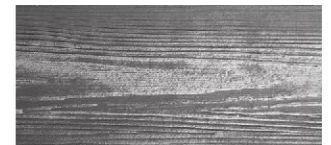

*Spruce surface

AVAILABLE COLOURS**:

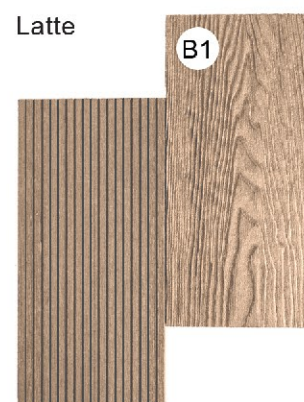
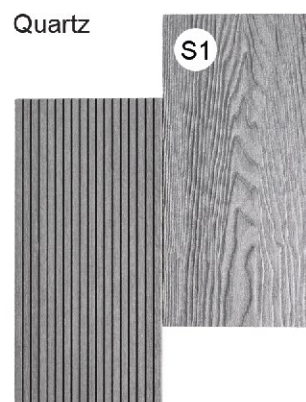
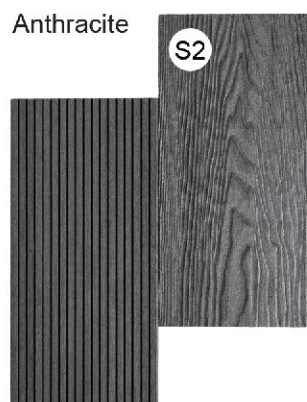

**PERFECT BOARD
FOR LUXURIOUS,
DAZZLING AND
COMFORTABLE
TERRACES!**

**We recommend to use samples for more accurate colour selection.
To order samples please email: info@wpc.plus info@ecodeckprofile.lv (Latvia)
 info@ecodeckprofile.be (Belgium)

To place an order and get information on availability, terms of delivery and special offers get in touch with us by phone:

LATVIA, LV-1010 RIGA ☎ +371 26323290 ☎ +371 28882939
BELGIUM BE-3680 NEEROETEREN ☎ +32 493762830

Terrace board «Style»

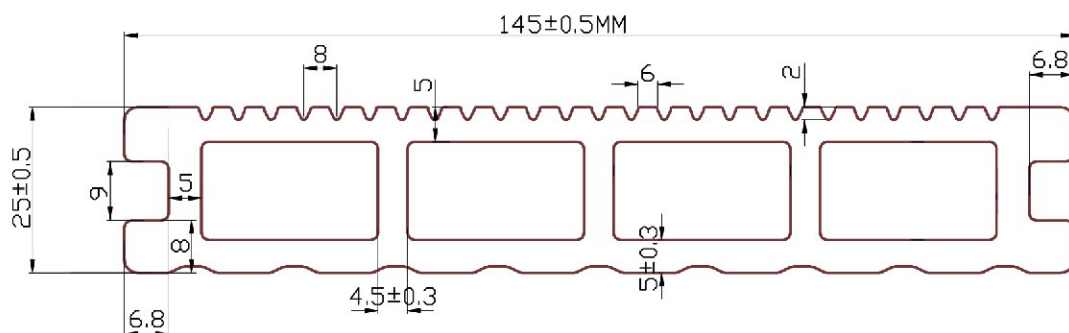

SURFACE TYPE: double-sided – "Wide Velvet"/"Velvet", brushed

SIZE: 145*25 mm

LENGTH: from 1 to 12 meters

LINEAR WEIGHT: 1,9 kg

DENSITY: 1,3 g/cm³

CONSUMPTION (m.p./1m²): 6,65

AVAILABLE COLOURS*:

Anthracite

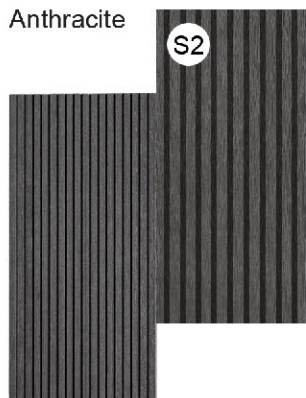

Quartz

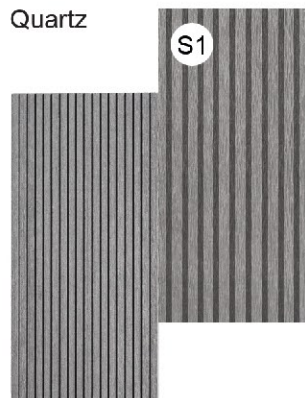

Terracotta

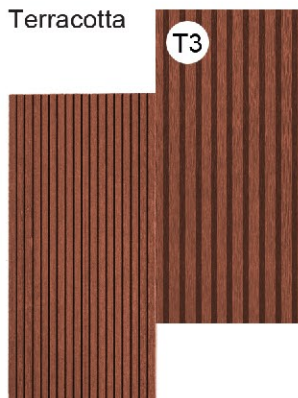

Dark chocolate



Nut tree

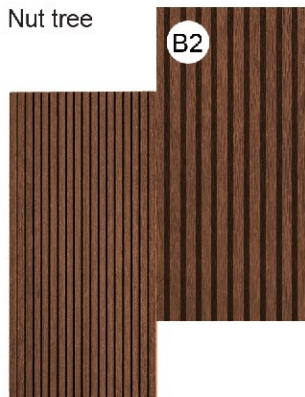

Latte

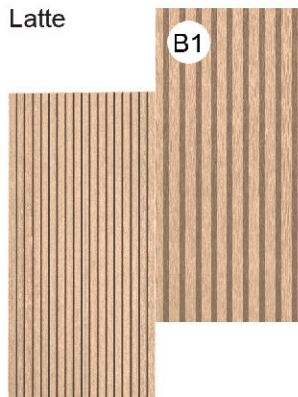

**We recommend to use samples for more accurate colour selection.
To order samples please email: info@wpc.plus info@ecodeckprofile.lv (Latvia)
 info@ecodeckprofile.be (Belgium)

To place an order and get information on availability, terms of delivery and special offers get in touch with us by phone:

LATVIA, LV-1010 RIGA ☎ +371 26323290 ☎ +371 28882939

BELGIUM BE-3680 NEEROETEREN ☎ +32 493762830

WPC Fencing board

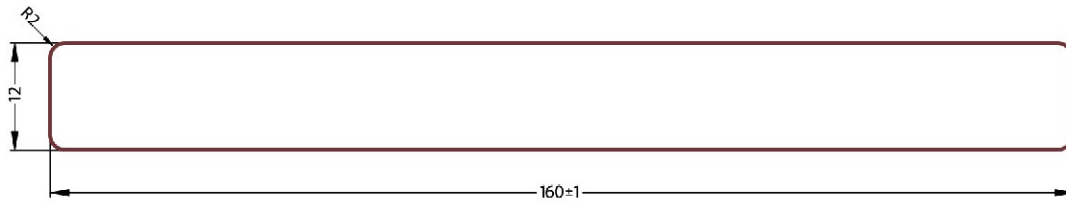

SURFACE TYPE: "OLD WOOD" + brushing on 2 sides or "Velvet"*

SIZE: 12*160 mm

LENGTH: from 1 to 12 meters

LINEAR WEIGHT: 2,48 kg

DENSITY: 1.3 g/cm³

CONSUMPTION (m.p./1m²): 6.25

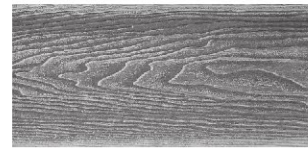

*Pine surface

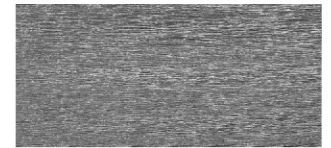

*Velvet surface

BRUSHING:

1. Double sided
2. One sided per request
3. No brushing per request

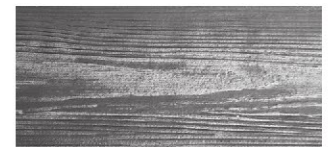

*Spruce surface

AVAILABLE COLOURS**:

Anthracite



Quartz



Terracotta



Dark chocolate



Nut tree



Latte



**GREAT CHOICE
FOR FENCE,
FACADE,
WIND BOX!**

**We recommend to use samples for more accurate colour selection.
To order samples please email: info@wpc.plus info@ecodeckprofile.lv (Latvia)
info@ecodeckprofile.be (Belgium)

To place an order and get information on availability, terms of delivery and special offers get in touch with us by phone:

LATVIA, LV-1010 RIGA ☎ +371 26323290 ☎ +371 28882939
BELGIUM BE-3680 NEEROETEREN ☎ +32 493762830

WPC Steps with anti-slip coating

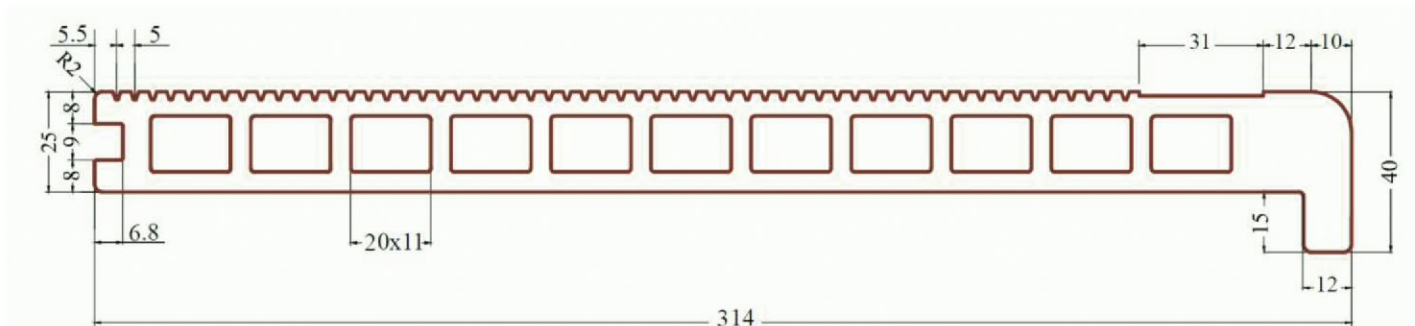

SURFACE TYPE: "Velvet" + anti-slip tape
 SIZE: 314*25 mm
 LENGTH: from 1 to 6 meters
 WEIGHT METER: 6.5 kg
 DENSITY: 1.3 g/cm³
 CONSUMPTION (m.p./1m²): -

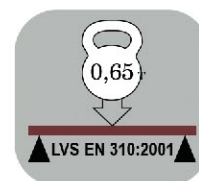

AVAILABLE COLOURS*:

Anthracite



Quartz

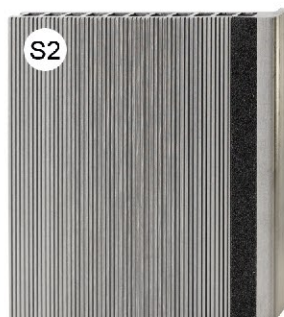

Terracotta



Dark chocolate

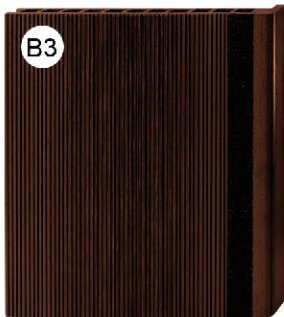

Nut tree

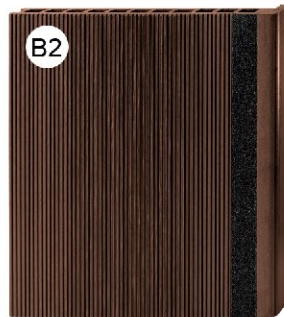

Latte

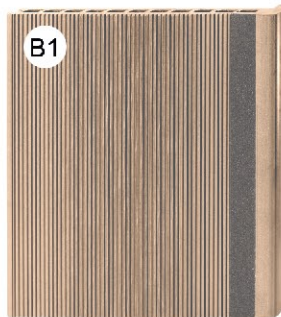

**BEAUTIFUL,
 DURABLE LADDER.
 FAST AND AFFORDABLE!**

**We recommend to use samples for more accurate colour selection.
 To order samples please email: info@wpc.plus info@ecodeckprofile.lv (Latvia)
info@ecodeckprofile.be (Belgium)

To place an order and get information on availability, terms of delivery and special offers get in touch with us by phone:

LATVIA, LV-1010 RIGA ☎ +371 26323290 ☎ +371 28882939
 BELGIUM BE-3680 NEEROETEREN ☎ +32 493762830

Mounting log

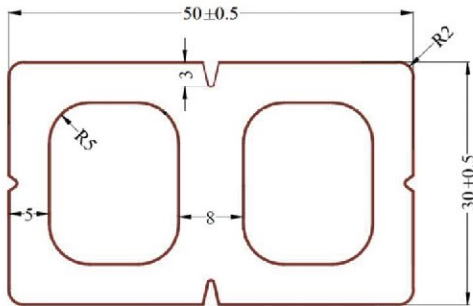

*BRUSHING:

1. Double sided + 10%
2. One sided per request + 10%

*Brushing on mounting log is used for decoration purposes (fencing, pergolas etc)

AVAILABLE COLOURS**:

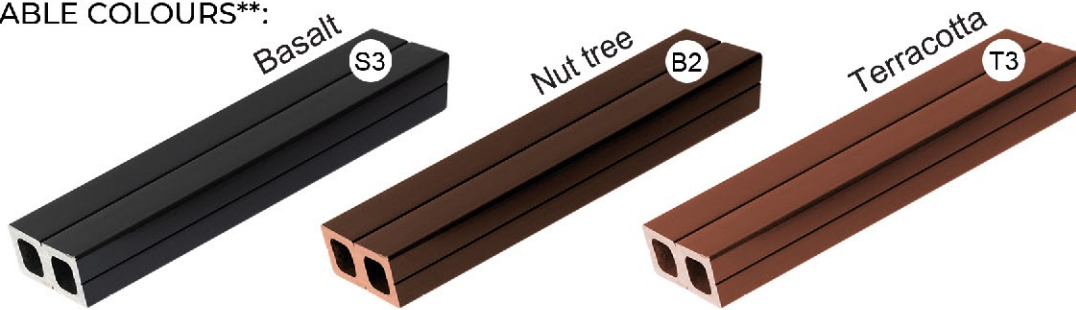

Fastening clip

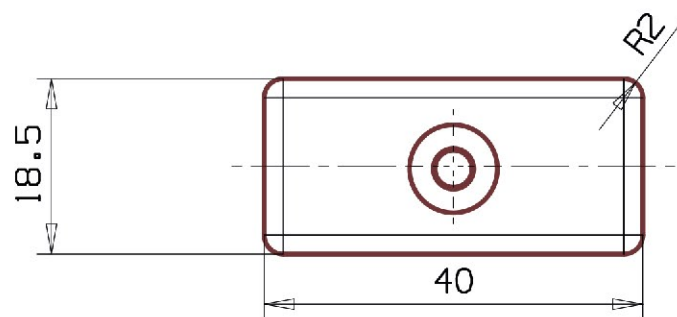
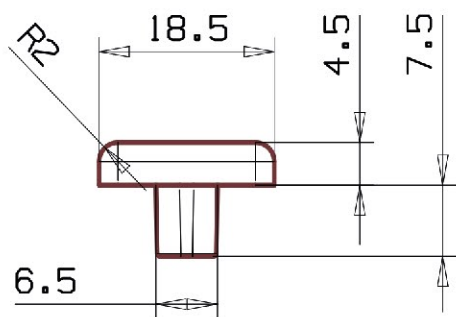

****We recommend to use samples for more accurate colour selection.**
 To order samples please email: info@wpc.plus nfo@ecodeckprofile.lv (Latvia)
 info@ecodeckprofile.be (Belgium)

To place an order and get information on availability, terms of delivery and special offers get in touch with us by phone:

LATVIA, LV-1010 RIGA ☎ +371 26323290 ☎ +371 28882939
 BELGIUM BE-3680 NEEROETEREN ☎ +32 493762830



High-strength decking board "Industry"



Created on the basis of binding components produced by E.L.L. Deutschland GmbH (Germany).

Terrace boards and steps in the "Industry" design are specially created for terraces and stairs

- used in particularly difficult conditions, under high mechanical loads: exposed roofs, restaurant terraces, piers and pontoons.

NL-K-51 material is specially designed for WPC production.

- Natural material (70% wood).

Testing of WPC based on NL-K-51 material was carried out in Germany in accordance with

- ISO178:2010, ISO179-1:2010, ISO2039-1:2001, ISO 1183, ISO 62-80.

The material has a unique strength. According to tests at the Institute of Polymer

- Mechanics (Riga), the presented samples of decking boards could withstand more than 900 kg. (a regular high-quality decking board can withstand no more than 450 kg).

The hollow deck board in the "Industry" design perfectly withstands impact loads.

- A drop of a hammer weighing 1 kg from a height of 2 meters leaves no marks on the surface.

The "Industry" board has a high surface quality, is resistant to abrasion, has excellent scratch

- resistance, and is not susceptible to scuffing and chipping.

Durable and resistant to UV radiation. The minimum service life according to the material

- manufacturer is at least 15 years.

The material was tested in

the ageing chamber of the

Riga Technical University.

Terrace boards and steps in the "Industry"

- design are an ideal solution for commercial properties.

Guaranteed German quality material.

Any of the EcoDeckProfile products can

- be made from NL-K-51 material.

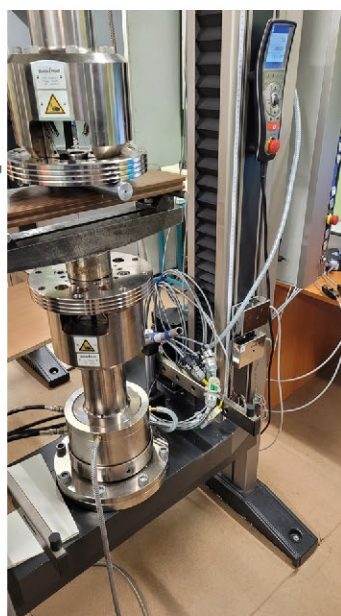

30.11.23

Zwick / Roell

Test report

Heading : Test report
 Customer : EcoDeck Profile 3BA
 Type and designation : WPC Terrace Board
 Material : WPC
 Tester : ILL Mestakle mehhanika Instituts Vite, Maris
 Test speed : 50 N
 Test speed : 5 mm/min

No.	Specimen no.	Specimen designation	Specimen ID	F _{max} N	dL at F _{max} mm	S ₀ mm²
1	1	1_pretis	WPC mabars	9150	18.5	3625.00
2	2	2_mabars	WPC mabars	9140	28.5	3625.00
3	3	3_pabals_3_mabars	WPC pabals_3_mabars	9770	8.9	3625.00
4	4	4_pretis	WPC mabars	9240	28.9	3625.00

Series graph:

Statistics:

Series	Specimen no.	F _{max} N	dL at F _{max} mm	S ₀ mm²
x	3	9770	21.4	3625.00
s		2319	9.8	0.00
VF04	51.64	31.26	48.74	0.00

Terrace board EcoDeckProfile

WPC decking board (Wood Polymer Composite) is perfect for terraces, balconies, pool areas, flowerbeds and fencing. This is high quality product with great performance. EcoDeckProfile composite boards are superior to natural wood products in terms of their strength and durability.

Manufactured from high-quality raw materials, using the most modern equipment. Terrace board EcoDeckProfile surpasses the products of most competitors in many ways.

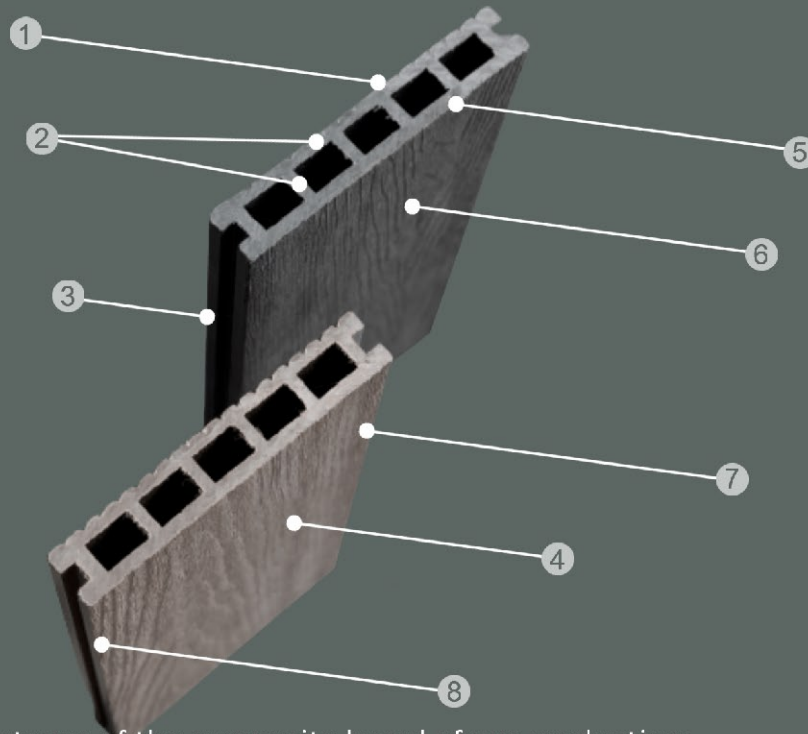

The main advantages of the composite board of our production:

1

Very high strength! The bearing capacity of the EcoDeckProfile decking board, according to the test results of the Institute of Polymer Mechanics (IPM) of the University of Latvia, is **420 kg**. Test Report 2207-01 dated 08/02/2022. One of the most durable WPC boards on the market.

2

The thickness of the upper surface of the board (!) 5.8 mm, and 4 partitions 5 mm thick, helps to distribute the load more evenly. Prevents deflection under load. This is a very strong and durable board. **Weight 1 m. p. 2.6 kg**.

3

Great usage life (up to 25 years). Not subject to decay. Does not require special care. Contains UF stabilizers – does not degrade in the sun. Weather resistance tested in aging chamber RTU (Riga Technical University) Test Report 2092 on 08/30/2022.

4

Does not slip in any weather. Deep 3D embossing "OLD WOOD" on one side and classic "Velvet" on the other side makes the EcoDeckProfile decking board non-slippery.

5

Easy to clean, does not require special care (painting, impregnation). This is achieved due to the high density of the material, the absence of pores and voids.

6

Design inspired by nature. Deep 3D embossing "OLD WOOD" repeats the structure of natural pine. Natural colours and shades.

7

Resistance to fading in the sun. The applied inorganic dyes will retain the saturated colour of the material for a long time.

*Possible slight colour changes in the first year of operation.

8

Building specialists will appreciate the simplicity and ease of installation. Fastens with standard clips and corners. Can be easily adjusted by cutting tool.

Advantages of EcoDeckProfile WPC steps with anti-slip tape

The WPC steps with anti-slip tape is EcoDeckProfile's own development. Steps greatly simplify the installation of the porch, garden stairs, terrace or balcony framing. Just like the EcoDeckProfile decking, the steps are made from high quality materials.

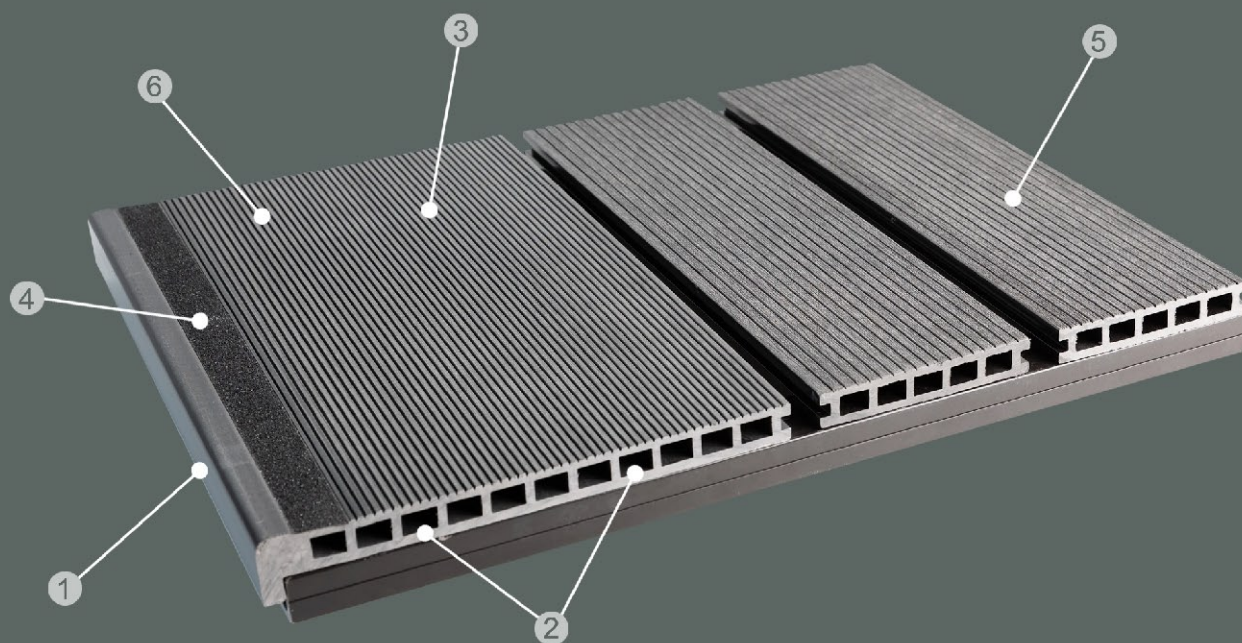

1 **Bearing capacity** of the step is **650kg**, according to the test results issued by the Institute of Polymer Mechanics (IPM) of the University of Latvia. Test Report 2207-01 dated 08/02/2022.

2 **High strength** is ensured due to the high quality of materials and the reinforced structure of the board itself: the thickness of the upper surface (!) is 5.8 mm, the partitions are 5 mm.

3 **Long lasting performance** (up to 25 years). Does not require special care. Contains UF stabilizers – does not degrade in the sun. Weather resistant, tested in RTU (Riga Technical University) Test Report 2092 on 30/08/2022.

4 **Does not slip in any weather.** Anti-slip tape provides perfect grip.

5 **Matches perfectly** with EcoDeckProfile decking. Available in a single design and colour range.

6 Building specialists will appreciate the simplicity and ease of installation. Fastens with standard clips and corners.

Work examples



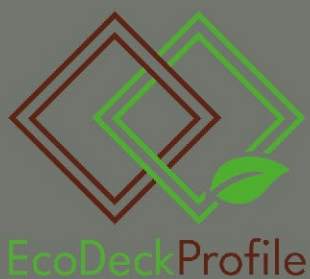

CONTACT

RIGA, LATVIA

☎ +371 26323290 ☎ +371 28882939

✉ info@ecodeckprofile.lv
www.ecodeckprofile.lv

BELGIUM, BE-3680 NEEROETEREN

☎ +32 493762830

✉ info@ecodeckprofile.be